

# TILE BRIDGE

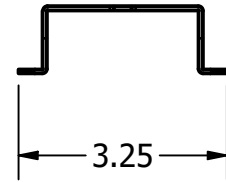

# TRIM (SPECIFIC TO ACCESS POINT)

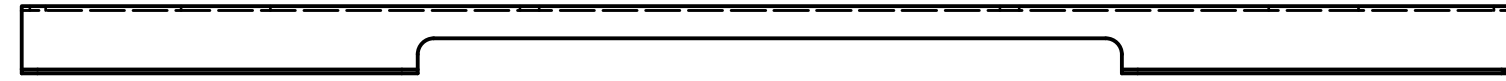
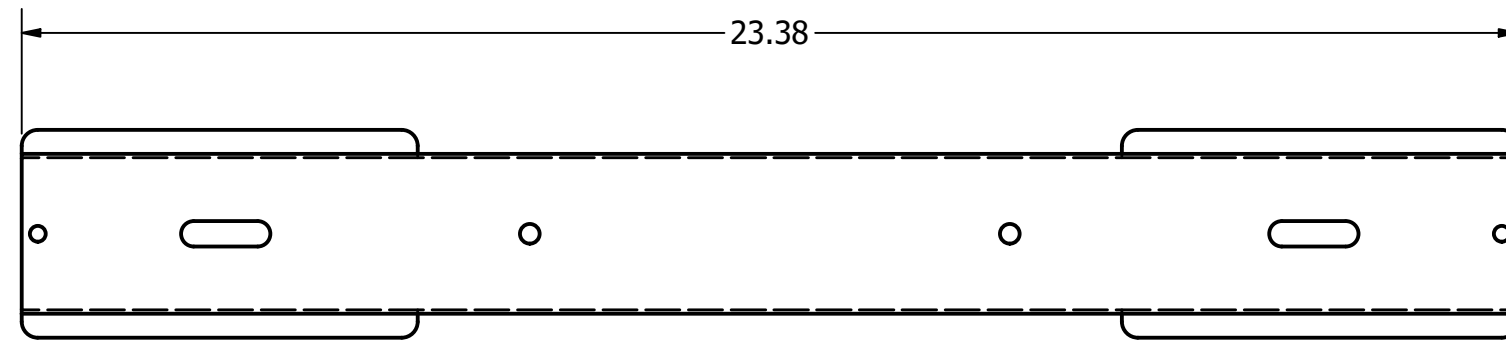
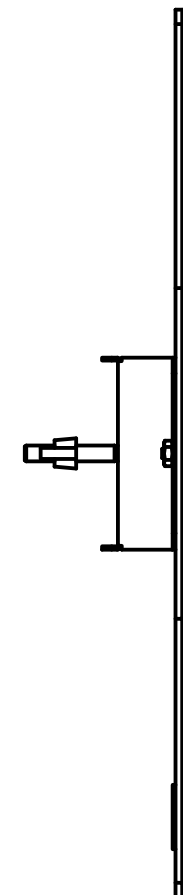
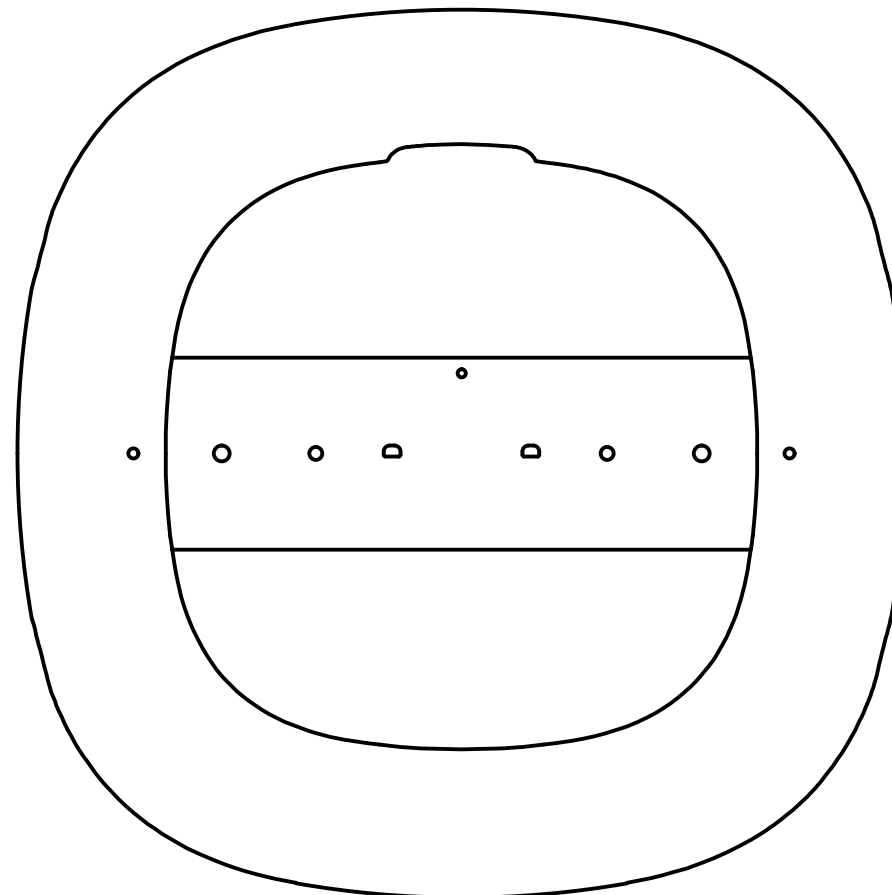
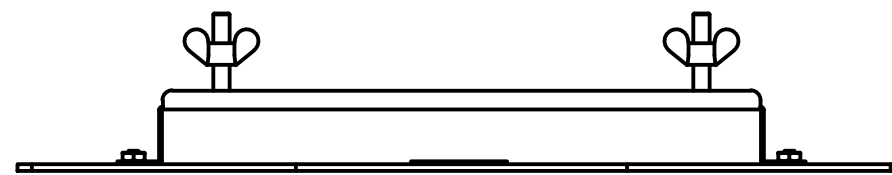

NOTE: Dimensions based on requirements of access point associated with trim

## REVISION HISTORY

ZONE	REV	DESCRIPTION	DATE	APPROVED
All	1	Released	4/3/2019	RLC
All	2	Updated model table	7/17/2019	RLC
All	3	Updated Model Table	12/4/2019	CAH

## TABLE

Access Point	Oberon Model	Trim P/N
Cisco 2800/3800	1039-CCOAP3800	37-1039-CCOAP3800
Cisco 4800	1039-COAP4800	37-1039-COAP4800
Cisco 9115	1039-COAP9115	37-1039-COAP9115
Cisco 9117	1039-COAP9117	37-1039-COAP9117
Cisco 9120	1039-COAP9120	37-1039-COAP9120
Aruba AP534/535	1039-ARAP535	37-1039-ARAP535

## NOTES:

- Weight: 4 lbs.
- Material:  
Ceiling Tile Bridge: 16 Ga. Galvanized Steel  
Trim: White Powder Coated Aluminum

## Includes:

- Ceiling Tile Bridge
- Trim, Specific to Access Point
- Required Hardware
- (2) Grid Wires

Oberon, Inc. - 1315 S. Allen St. - State College, PA 16801

TITLE

Model 1039-XX

SIZE	DWG NO	DATE
C	1039-XX	12/4/2019
SCALE	SHEET 1 OF 2	

4 3 2 1

D C B A

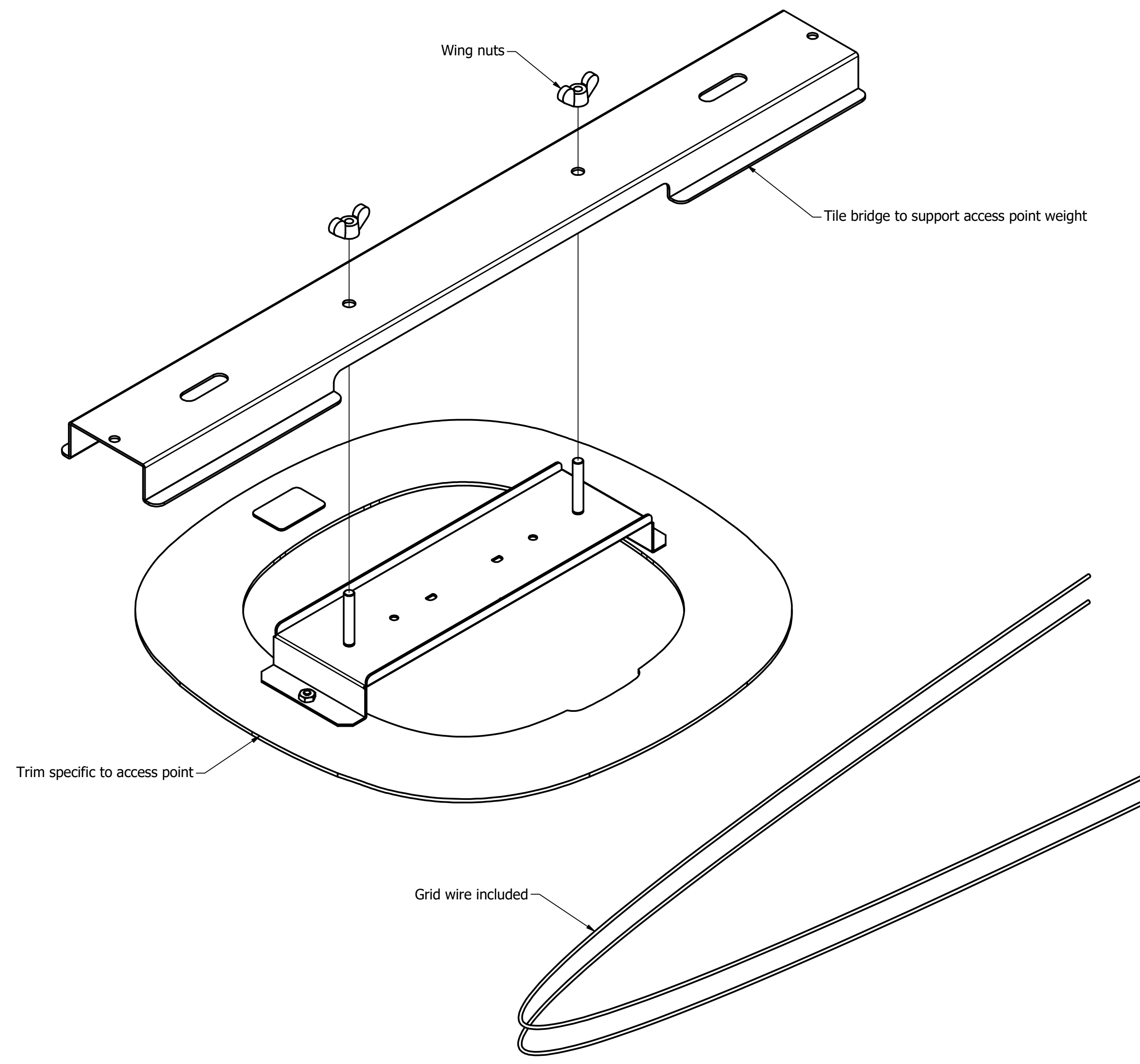

Oberon, Inc. - 1315 S. Allen St. - State College, PA 16801			
TITLE			
Model 1039-XX			
SIZE	DWG NO	DATE	
C	1039-XX	12/4/2019	
SCALE	SHEET 2 OF 2		

4 3 2 1