

REVISION HISTORY				
ZONE	REV	DESCRIPTION	DATE	APPROVED
All	1	Released	4/17/2020	CAH
All	2	Updated Views, "Includes" List	5/11/2020	CAH
All	3	Removed Metal Snap-in Plug; Updated Views, Notes, "Includes" List, and Mounting Legend	8/13/2020	CAH
All	4	Replaced Base Enclosure, Bottom Panel, & Cover with Updated Parts	8/17/2020	CAH
All	5	Changed UL rating from "UL94-5VB" to "UL94-5VA"	9/23/2020	CAH
Pg. 1	6	Added Installation Instructions to View and "Includes" List	9/30/2020	CAH
All	7	Added Self-Centering Plug; Removed FireStop Grommet; Updated "Includes" List	10/12/2020	CAH
All	8	Added Page Showing Views of Self-Centering Plug; Replaced Conduit Connector	10/16/2020	CAH
All	9	Updated Views. "Includes" List	1/11/2021	CAH

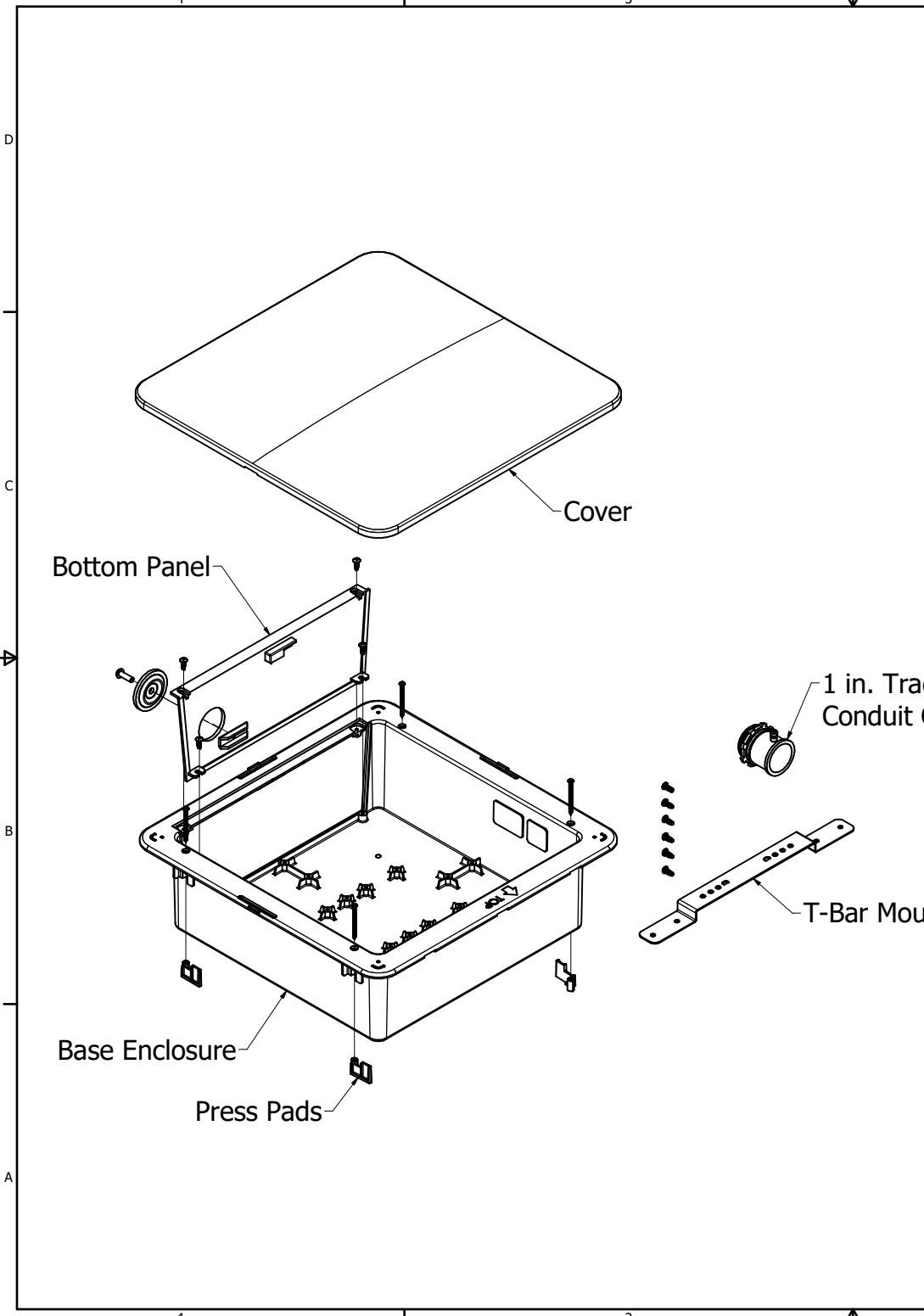

NOTES:

- Weight: 2 lbs
- Material:
White, Textured UL 94-5VA Flame Retardant
PC/ABS Plastic Enclosure
18 Ga. Galvanized Steel T-Bar Mount

Includes:

- (1) Base Enclosure
- (1) Bottom Panel
- (1) Cover
- (1) T-Bar Mount
- (4) Press Pads
- (10) #6-19 x 3/8" Pan Head Thread-Forming Screws for Plastic
- (4) #4-24 x 1-1/2" Pan Head Screws
- (4) #6-32 x 1/4" Pan Head Machine Screws
- (4) #6 Washers
- (4) #6-32 Hex Nuts
- (1) Self-Centering 1 in. Trade Size Hole Plug, UL Listed
- (1) 1 in. Trade Size Conduit Connector, UL Listed

DRAWN	CAH	1/11/2021	Oberon, Inc. - 1315 S. Allen St. - State College, PA 16801		
CHECKED	CAH	1/11/2021	TITLE		
QA			Model 1018-00		
MFG	CAH	1/11/2021	SIZE	DWG NO	REV
APPROVED	CAH	1/11/2021	C	1018-00	9
TOLERANCE:			SCALE		
		.0 = +/- .030			
		.00 = +/- .015			
		.000 = +/- .005			
				SHEET 1 OF 4	

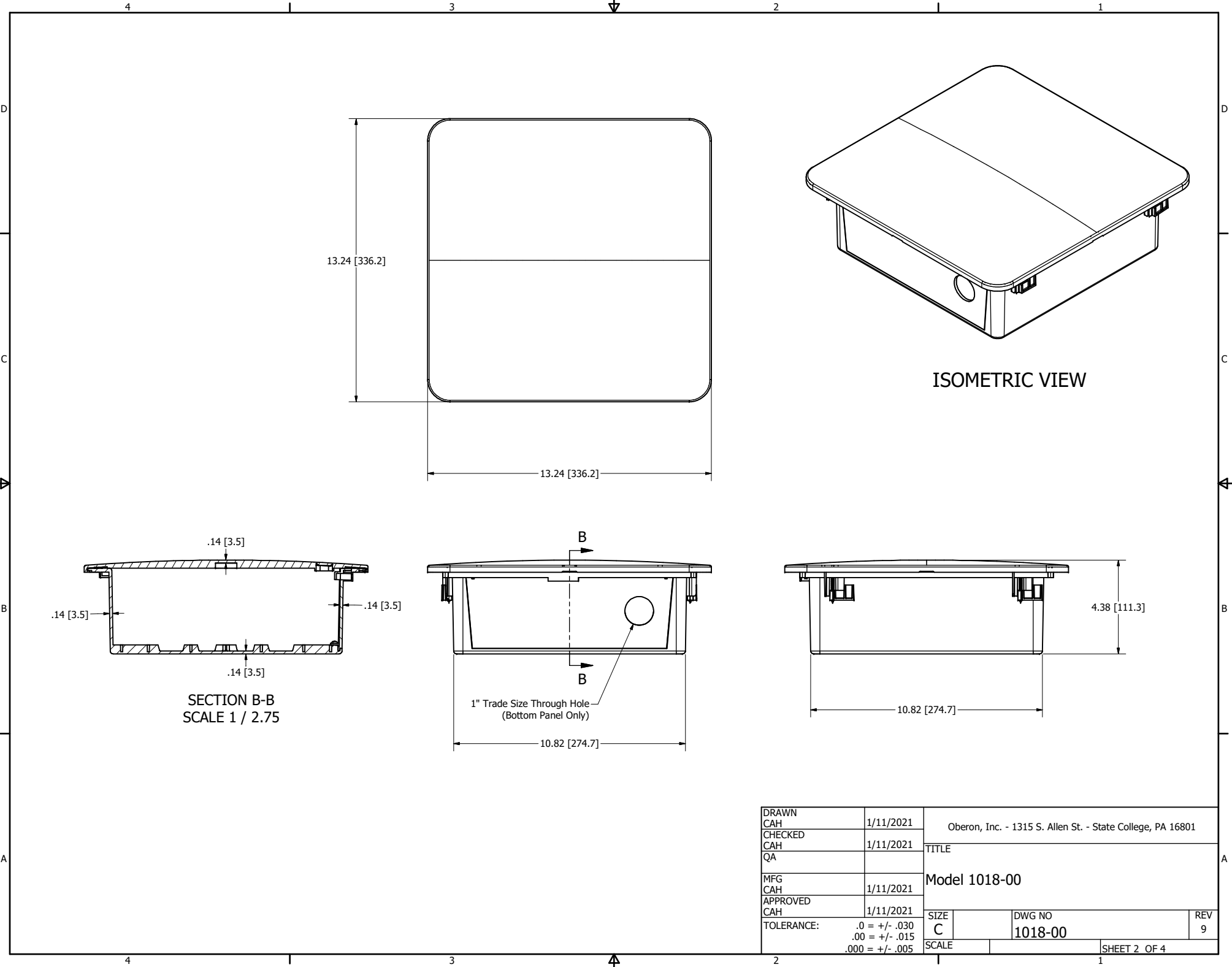

DRAWN CAH	1/11/2021	Oberon, Inc. - 1315 S. Allen St. - State College, PA 16801		
CHECKED CAH	1/11/2021	TITLE		
QA		Model 1018-00		
MFG CAH	1/11/2021	SIZE C	DWG NO 1018-00	REV 9
APPROVED CAH	1/11/2021	SCALE	SHEET 2 OF 4	
TOLERANCE:	.0 = +/- .030 .00 = +/- .015 .000 = +/- .005			

Self-Centering Hole Plug

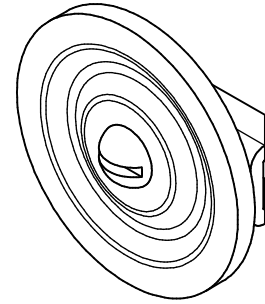
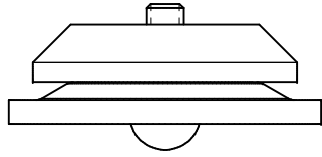

ISOMETRIC VIEW

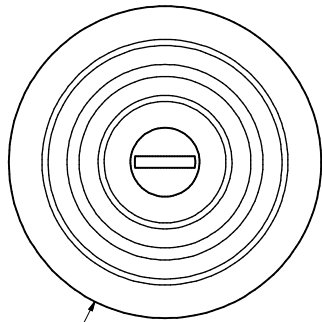

Ø1.63 [Ø41.3]

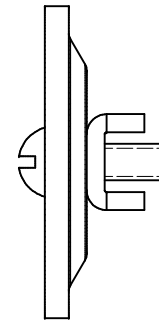

NOTE:

- Material:
16 Ga. (0.060") Steel Plug

DRAWN CAH	1/11/2021	Oberon, Inc. - 1315 S. Allen St. - State College, PA 16801		
CHECKED CAH	1/11/2021	TITLE		
QA		Model 1018-00		
MFG CAH	1/11/2021	SIZE C	DWG NO 1018-00	REV 9
APPROVED CAH	1/11/2021	SCALE	SHEET 3 OF 4	
TOLERANCE:	.0 = +/- .030 .00 = +/- .015 .000 = +/- .005			

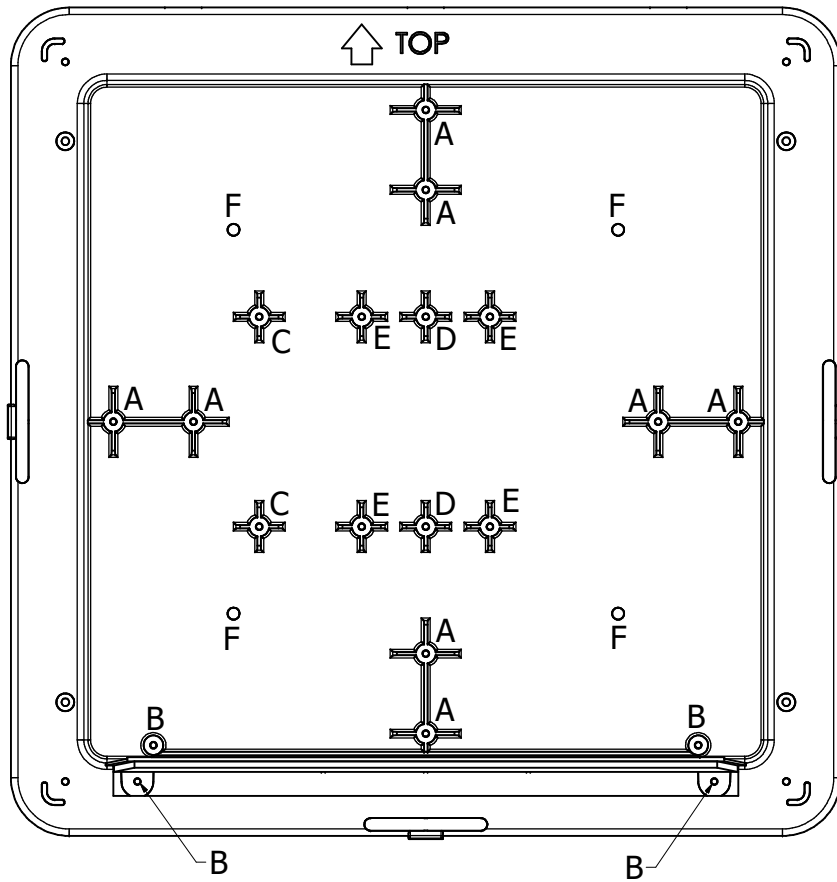

AP Mounting Legend

- A - Oberon T-Bar Bracket
- B - Bottom Panel
- C - Single Gang Outlet Box for Meraki Mounting Bracket
- D - Single Gang Outlet Box
- E - Double Gang Outlet Box
- F - General Purpose Through Holes

DRAWN CAH	1/11/2021	Oberon, Inc. - 1315 S. Allen St. - State College, PA 16801		
CHECKED CAH	1/11/2021	TITLE		
QA		Model 1018-00		
MFG CAH	1/11/2021	SIZE C	DWG NO 1018-00	REV 9
APPROVED CAH	1/11/2021	SCALE	SHEET 4 OF 4	
TOLERANCE:	.0 = +/- .030 .00 = +/- .015 .000 = +/- .005			